

Bring you warmth in your life!

THERMOSIPHON SOLAR WATER HEATER

CUSTOMER MANUAL



Dear users,

Thank you for choosing our solar water heater, in order to use it more efficiently, please read the manual carefully first and use the solar water heater according to it.

Content

- ◆ Structure of the product..... 1

- ◆ Major performance feature.....2

- ◆ Notice of installation.....3

- ◆ Location selection.....4

- ◆ Assembly introduction of the solar water heater..... 5

- ◆ Guideline for Users.....6

- ◆ Simple maintenance.....7

- ◆ Frequent Trouble Shooting.....8-9

◆ Structure of the product

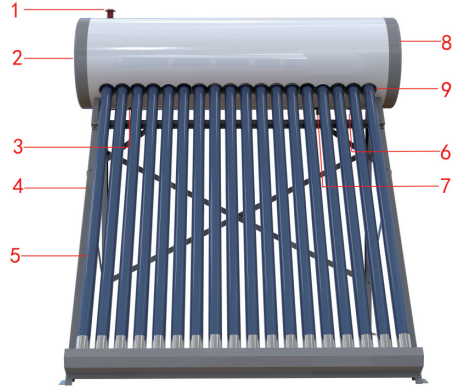

1



7



8



1	Air vent hole/ Assistant tank hole	6	Inlet for cold water
2	Solar water heater tank	7	Electric heater hole
3	Outlet for hot water	8	Sensor hole
4	Frame	9	Anti-dust ring
5	Vacuum tube		

◆ Major performance feature

- A. It can work all year. Whatever the weather is, like snowy or rainy, daytime or night, the assistant electric style can provide the hot water for shower.
- B. Hurricane resistance, hail resistance, coldness resistance
- C. High absorb efficiency, adopt the advanced selective absorb layer, the tube has a unique effect of absorption, whose temperature can reach 380°C.
- D. High insulation performance is achieved by foaming polyurethane, lower heat-loss. It could keep temperature constant for 72 hours.
- E. The inner tank is made of high-quality SUS-2B food grade stainless steel which is no harm to the health and complete anti-corrosion design.
- F. Adopt imported silicone rubber sealing circle with long use life, which is high temperature resistance, non-toxic and non-odor, ensuring the user can enjoy pure water.

Adopt intelligent control instrument system guaranteeing the convenient use.

Use positive electrode water fouling removal bar system which can soften water.

Accessories can be selected by users.

◆ Notice of installation

1. Before installation, the manual should be read carefully and follow strictly.
2. Always assess the risks before you start installation.
3. The installation of the solar water heater is a hazardous high-altitude operation, which must be operated very carefully.
4. Take care when carrying the accessories to the roof. Carrying and manipulating heavy weights and large frames onto a roof are difficult and must be chary.
5. Always make sure you have sufficient people to help you in your work.
6. Always comply with all instructions and regulations of wiring and electrical, including bond rules, when installing the pump station and controller. (If you buy them for your solar water heater.)
7. Do not commence the installation until you are satisfied with yourself, also all occupational healthy and safety issues associated with working and lifting components onto a roof have been addressed. All work which is associated with the installation must comply with local authority regulations. If these installation instructions and local regulations are in conflict, the local regulations must prevail.
8. The solar water heater must be installed in an area that is free of shade all year round. Ensure that trees do not shade the heater, particularly in winter.
9. All electric wiring should be enclosed in waterproof plastic or metal conduit with watertight fittings. An ON/OFF switch must be installed in the home at a convenient location, such as in the kitchen or laundry room.
10. All the installation of the plumbing should be in accordance with the building and plumbing codes appliance in your area. Plastic piping should not be used for any hot water piping running, due to the high temperature and pressure that whole solar water heating system operate with.

◆ Location selection

There are five major factors to consider when selecting the solar water heater installing location:

1. For optimum performance, the solar collectors need face the sunshine. Installation on the angle of 38° - 52° between the sunshine radiate and the solar collector.
2. Careful location inspection is required to ensure the selected location is not suffered shading from adjacent trees or buildings throughout the day ,particularly between 9am and 3pm the highest solar input time. Shadow is longer in winter than in summer, so the location that is free of shadow from adjacent objects in summer, but some shadow in winter.
3. The location of the solar water heater installed should be a minimum of 3 feet up from the roofs lower edge, 3 feet in from either side of the roof, and 3 feet down from the roof ridge line. Also it should be as close as possible to the room which use the most hot water, such as bathroom and kitchen. This is to reduce energy losses which may occur if the pipe, which works between the solar water heater and the point of usage, is too long.
4. To achieve optimum performance, the solar water heater should be installed on a roof slope of greater than 8° and less than 30° . Installing the system on a roof whose slope is greater than 30° need additional support at the water tank to prevent it moving downward after installation. If the roof slope is less than 8° , the system need a mounting frame(bracket) to increase the slope above 8° . If installation below 8° slope, the system can not do thermosiphon effectively and the solar collector glass will not self-clean during rainy period.
5. Careful inspection for the roof where the system install is essential to ensure it can support the system's weight after filling with water. Particularly emphasize the front foot of the water tank located. Typically front foot of the water tank should be located over a tile batten, purline or similar for maximum strength. If the roof can not support the system, additional bracing must be installed before installing solar water heater.

◆ Assembly introduction of the solar water heater

Following illustration is for your reference.

The solar collector must be installed below the water tank so that hot water will rise into the tank. These systems are reliable, but contractors must pay careful attention to the roof design because of the heavy water tank.

Assemble the bracket of two types

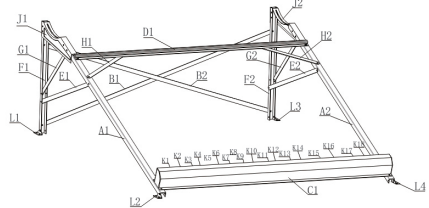
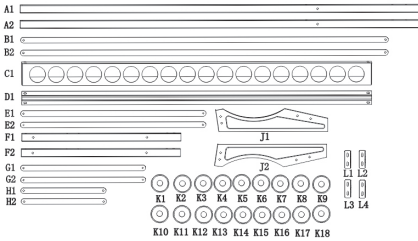

U Type Bracket

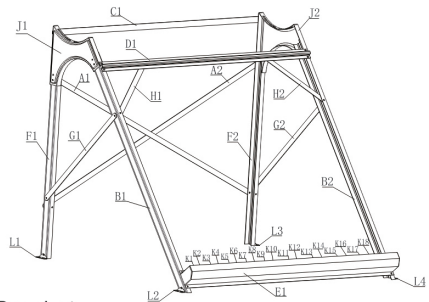
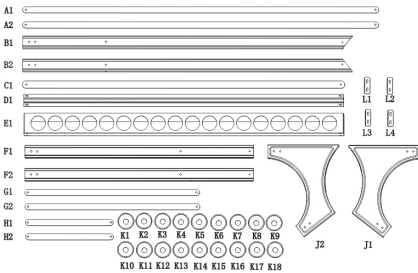

70MM Type Bracket

Put the water tank on the bracket, assemble the vacuum tube

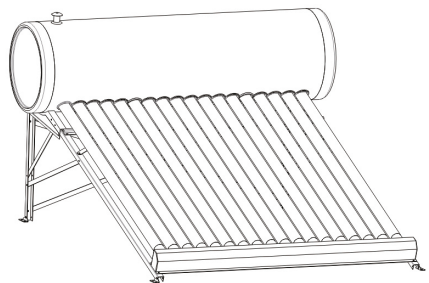
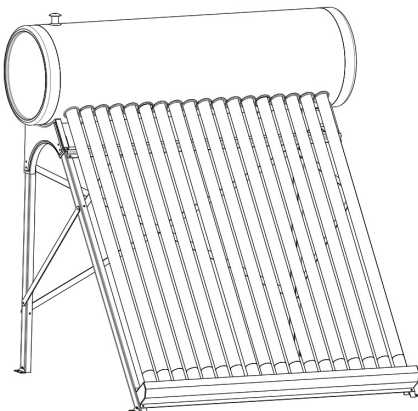

Note: When you prepare to insert the vacuum tube into the hole of the tank, please wet the upper part of the vacuum tube for inserting smoothly and safely.

◆ Guideline for Users

The temperature of the vacuum tube must be cool down, when filling water for the first time.

1. When you didn't want to use the solar water heater, the hot water outlet, nozzle valve and up-flow valve must be in close position. when fill the water, open the up-flow valve.
2. When the tank is full, water would flow out from the overflow pipe. Meanwhile , close the up-flow valve and open the hot water outlet for approximately 2 minutes until slightly drain the water from the water tank, which can prevent the loss of heat energy caused by hot water's outflow from the overflow pipe (If there is not mounted with intelligent controllers).
3. To prevent scalding caused by overheated water, it is advised to feel the water temperature with a hand before shower. When adjusting the temperature, the hot water valve shall be adjusted to a suitable shower temperature according to the season, sun radiation and water pressure.
4. In cold winter, when the room temperature is low, heating light and/or heating fans can be used to increase the room temperature. In extremely cold districts, such as the climate is below 15degree, when you don't want to use the solar water heater, the water in the pipeline shall be drained out completely during winter to prevent the freezing crack damage to the pipeline.(If you have the intelligent controller, you could use it to complete this operation automatically.)
5. In summer, water filling must be done immediately after the hot water was used up or at night. Otherwise, water in the tubes can be vaporized after long exposure of sunshine, then the temperature of the tubes will be up to 250℃, so if you fill water at this time will lead to crack the tubes. (If you have the intelligent controller, you could use it to load the water to the tank automatically.)
6. In spring, summer and autumn, if the solar water heater isn't used for several continuous sunny days when the tank is full, cautions shall be taken for a possible of empty tank due to vaporization, thus water feeding shall be done at night.
7. Prior to using the electric heating device, make sure the electricity leakage protector and the fuse are in good order. Fill the tank up to water before switch on the power. Heating the system when the tank is without water is strongly prohibited and making sure that switch off the power after the heating.

⚠ It is strongly prohibited to bathe with presence of electricity !!!

8. Please don't shower when there is a thunderstorm and fill up the tank when there is a hurricane.
9. In summer, if the hot water use is little or the temperature is too high, you can use mask to cover some surface of the solar collector to reduce the heat absorption. Although it is a little inconvenient for you, it is safe and reliable more for you using the solar water heater.

◆ Simple maintenance

This system can be used all year round any time of the day with over 15 years if you do the simple maintenance.

1. Cleaning the vacuum tube

In the dusty district, the dust can adhere to the tubes, which can affect the absorption. Therefore, according to the amount of dust, the vacuum tube shall be clean once every half a year. When cleaning, use soap water or detergent to rub the tubes.

2. Remove the water scale

Because of the high temperature, water scales are liable to form in the water tank, especially in the tube, if the system located the areas where the water is hard or underground water is directly used. If the water contains too much impurity, the scale problem would be more serious. Long time use the tube with water scale can affect the thermal efficiency. According to the actual condition, it is necessary that cleaning should be done by professional person every 2 to 5 year.

◆ Frequent Trouble Shooting

Frequent troubles and tackling methods

1. Phenomenon: Water temperature unstable during sunny days

Cause:

- 1) There's obstruction in front of the solar collector, such as high balcony, trees, high buildings, fencing walls, and other solar water heater; or the sunny time is short.
- 2) The location, where the system installed, is at heavily polluted area or around the chimney, which affect the absorption of sunshine. The smoke and dust would cover the vacuum tube, which result in the low temperature.

Tackling methods:

- 1) Avoiding the obstructions away or move the solar water heater to a place clear from obstructions
- 2) Clean the surface of vacuum tube.

2. Phenomenon: Water isn't hot during sunny days

Cause:

- 1) Water leakage occurs on the valve of either up-flow pipe or down-flow pipe, causing the cold water occasionally enters the tank, and replaces the hot water, which results in the loss of hot water.
- 2) a. One or two vacuum tube have air leakage, which results in the low temperature of water.
b. The water contains too much soil or sand, which deposit in the vacuum tube and affect the solar absorption process or the circulation.
c. Incorrect installed angle.

Tackling methods:

- 1) Fasten the valves or change the valves.
- 2) a. Refer to the installation scheme, after the water used up, pull the vacuum tubes out and wash them. If there's any damage, notify the sales departments for a change.
b. For a good operation of solar water heater, the place selection is very important. Always adequate sunray must be available on the solar collector from morning to evening.

3. Phenomenon: Water leaks from the tank

Cause:

- 1) Damage of the sealing rubber or the position of the tank isn't right.
- 2) The joint on the water tank isn't fastened.

Tackling methods:

- 1) Change the sealing rubber or re-install it to ensure the alignment of the tank and tube.
- 2) Fasten the screw or change it

4. Phenomenon: Tank can't be filled up

Cause:

- 1) Low pressure of the tap water.
- 2) Leakage on up-flow and down-flow pipes
- 3) Leakage on the water tank

Tackling methods:

- 1) Add a mini pump
- 2) Change the valves or joints on the pipe
- 3) Notify the provider to change the tank

5. Phenomenon: No hot water supply in winter

Cause:

- 1) Up-flow and/or down-flow pipes get frozen in severe cold winter
- 2) The weather is too cold.
- 3) No insulating layer or galvanized pipes are used.

Tackling methods:

- 1) Use electric heating cord to heat the pipes
- 2) Open the hot water valve to allow hot water dripping slowly during the coldest winter nights to prevent freezing.
- 3) Commission the dealers to assist with the insulation (a cost will be charged).

6. Phenomenon: Water isn't hot on cloudy or rainy days

Cause:

- 1) No awareness of the weather condition of the next day.
- 2) Hot water completely used up last day and then early use of water the next day.
- 3) Fill in the tank too much water on cloudy or rainy days.
- 4) No electric heating device as backup.

Tackling Methods:

- 1) Appropriately add water according to the temperature.
- 2) Usually add the water to the tank till it's half full on cloudy or rainy days.
- 3) If the hot water isn't used all up on a day, fill less cold water or even no cold water in the tank at night.
- 4) Add an electric heating device or gas heating device to be parallel connection with the solar water heater.

Safe warning.



When showering, feel the water temperature with your hand to avoid scald

